



Article no.: M-1437

Product data:
**Behälter 16.000 Liter aus V2A,
gebraucht, isoliert,
Standing**

EUR 10.200,00

zzgl. 19 % MwSt. excl. shipping

in stock: 1

Location: 33378 Rheda-Wiedenbrück

Behälter 16.000 Liter aus V2A, gebraucht, isoliert consists of the material 1.4301(AISI304) V2A. The volume is approx. 16,000 litres. The diameter inside includes 2500 mm.

Behälter 16.000 Liter aus V2A, gebraucht, isoliert was last used in the following area: CIP/water tank.

1 pieces of Behälter 16.000 Liter aus V2A, gebraucht, isoliert is/are currently still available. Delivery can take place worldwide.

Product description

General

Material in contact with product 1.4301(AISI304) V2A

Volume approx. 16,000 litres

Structure Standing

DIN design unknown

Year of manufacture 1989

Manufacturer ABAB

Condition Used

Dimensions approx.

Internal diameter 2500 mm

External diameter 2600 mm

Cyl. height 3000 mm

Foot height 1000 mm

Total height 4500 mm

Design

Weight approx. 1500 kg

Insulation No

Insulated area Shell and floor

Insulation cladding Fully welded stainless steel

Interior surface Smoothed

Exterior surface Smoothed

Floor type Conical bottom

Head design Conical bottom

Product chamber operating pressure Atmospheric/unpressurised

Equipment

Temperature-controllable No

Agitator

Agitator unavailable

Supports

Supports Stainless steel feet
Number of feet 4 (piece)

Fixtures and fittings

Manway position In shell
Nozzles/connectors in shell 1xDN 65 1xDN 80 (piece)
Outlet nozzle 65
Cleaning/CIP nozzle in head
Fixtures and fittings
Additional fixtures and fittings

Other notices

Technical documentation None
Last usage CIP/water tank

Pictures

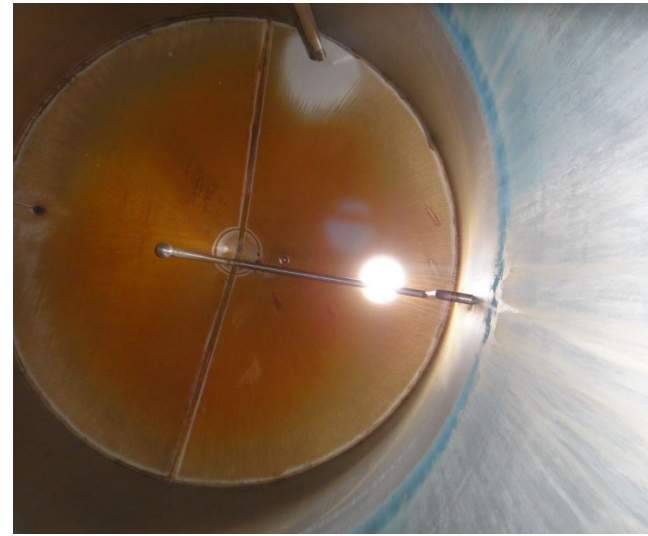
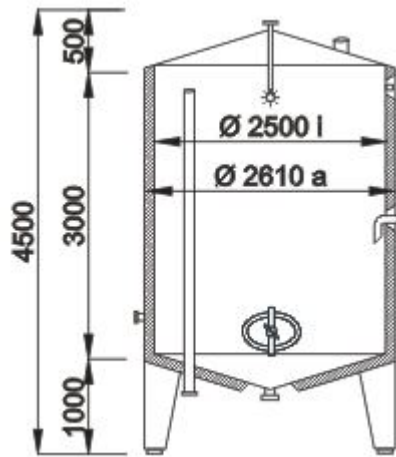

Terms and conditions

The general terms and conditions of Georg Heuer Behälterhandel und Industriebedarf GmbH apply. [View here.](#)